



Large Cabinet Racks  
**BudRack**  
**Professional Series**



## ***Design Features***

- Sturdy and durable steel construction - Mounting rails - 14 GA, other parts 18 GA.
- Finished complete with ventilated tempered glass front door, locking rear door, removable sides
- EIA 310 Compliant for 19" rack-mount equipment
- Two pairs of fully adjustable panel mounting rails included. The panel mounting rails include unique notch at each "U" point to allow for rapid equipment location identification
- Top mount fan box installed. Two fans for 23" depth, four fans for 31" depth
- Includes ventilated shelves (one shelf in the 24U high cabinet, two shelves in the 40U and 45U cabinets)
- Includes Installed Casters
- Large cutout in base. Cutout comes covered by 2.5" deep metal cover plates that allow for adjustable opening providing as much or as little open space for cable access
- Two (2) additional 13" x 2.5" cutouts in front and rear of base also come with readily removable covers
- Vented at top and bottom of sides, which also can be locked

- Comes fully assembled in a wooden crate to eliminate freight damage
- Finish: Black textured powder coating - easy to clean.
- Other sizes and modifications are available upon request.

**BudRack Professional Series**

Catalog No.	Drawings	Panel Space (inches)		"U"	Overall Dimensions (inches)			Clear Inside Depth (inches)	Weight (Lbs.)
		Width	Height		Width	Depth	Height		
BRP-12202		19.00	42.00	24	23.62	23.62	49.40	20.88	222
BRP-12206		19.00	70.00	40	23.62	23.62	77.40	20.88	305
BRP-12208		19.00	78.75	45	23.62	23.62	86.15	20.88	327
BRP-12212		19.00	42.00	24	23.62	31.50	49.40	28.75	254
BRP-12216		19.00	70.00	40	23.62	31.50	77.40	28.75	345
BRP-12218		19.00	78.75	45	23.62	31.50	86.15	28.75	370



MATERIAL:  
 PANEL MOUNTING RAILS - 14 GA. (0.08" [2.0] THK.) STEEL  
 ALL OTHER PARTS - 18 GA. (0.05" [1.2] THK.) STEEL

FINISH:  
 BLACK TEXTURED POWDER COATING

PANEL MOUNTING RAILS HAVE 0.35" [8.9] SQUARE HOLES  
 ON E.I.A. UNIVERSAL HOLE SPACING

SUPPLIED HARDWARE KIT TO INCLUDE:  
 QTY. (25) M6 CAGE NUT  
 QTY. (25) M6 PAN HEAD SCREW  
 QTY. (25) NYLON FLAT WASHER  
 QTY. (4) M10 x 2.25" [57.2] LG. STEM LEVELER W/HEX NUT  
 QTY. (8) KEYS

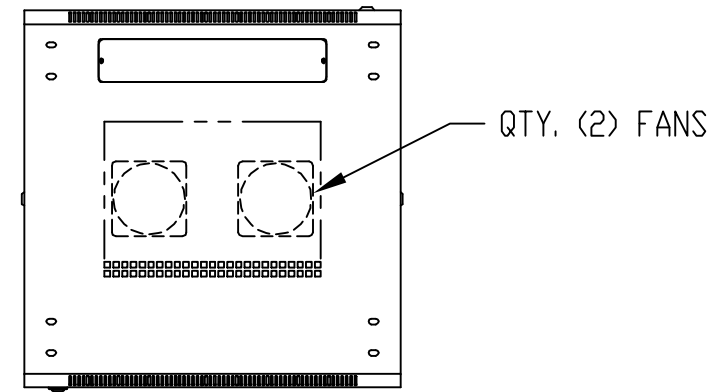

TOP VIEW

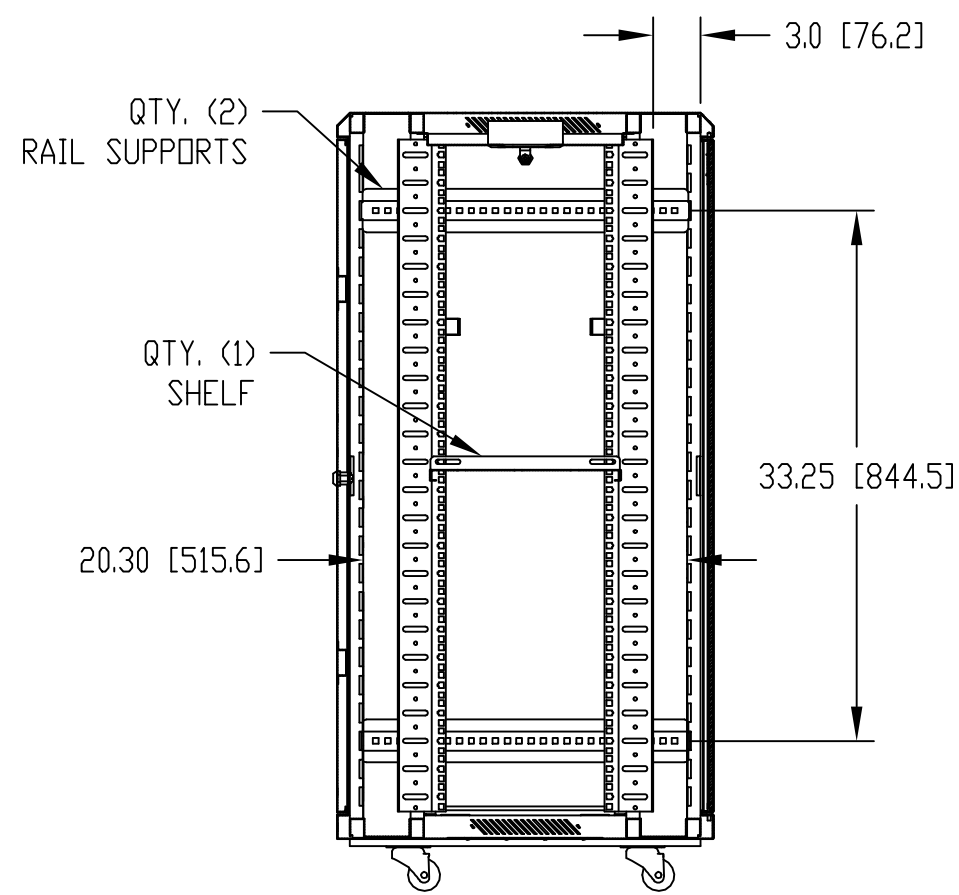

SECTION "A-A"

2.85 [71.6] REF. CASTER HT.

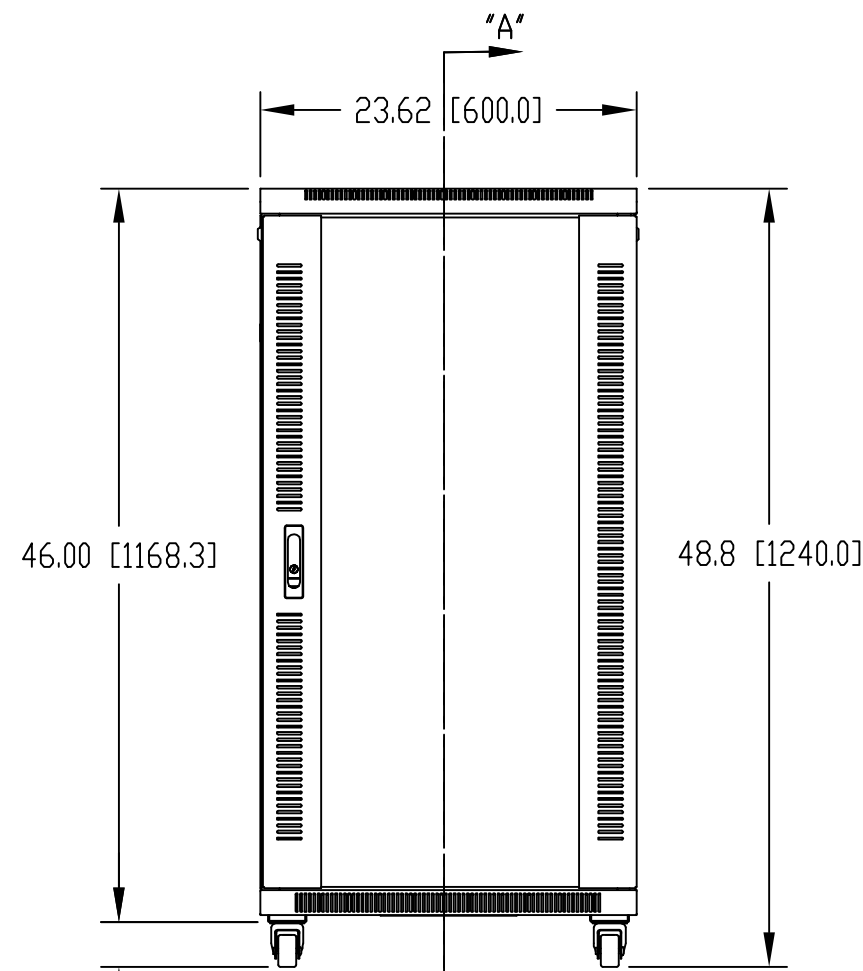

FRONT VIEW

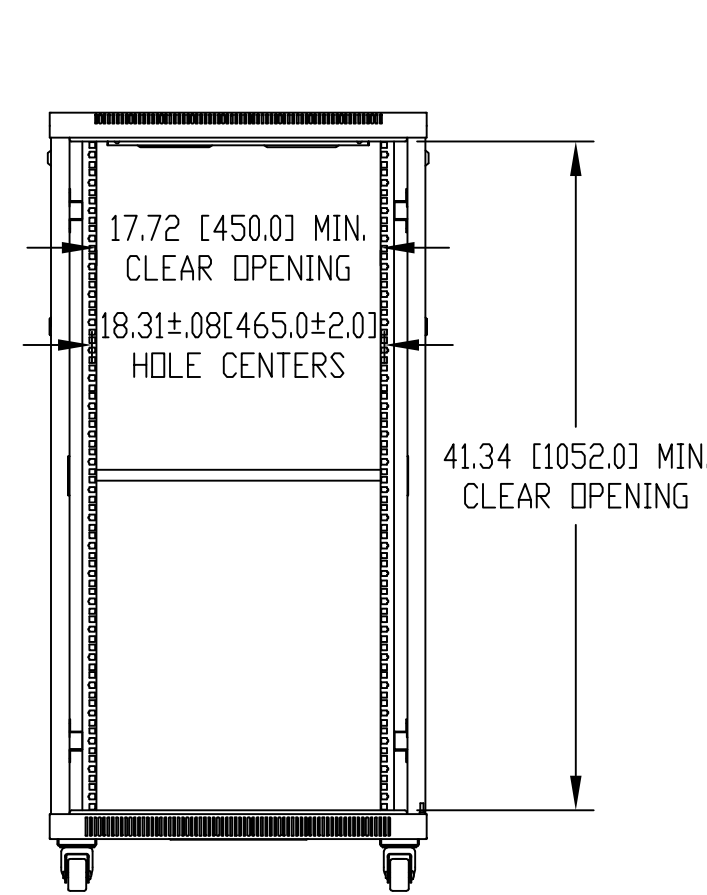

FRONT VIEW (DOOR REMOVED)

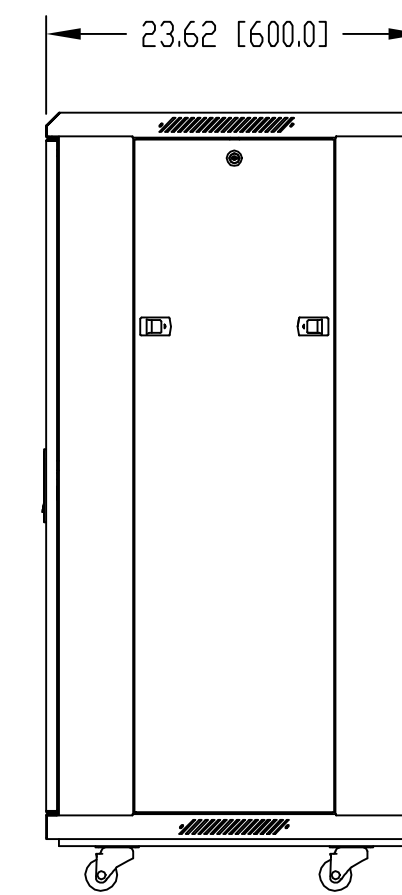

RIGHT SIDE VIEW

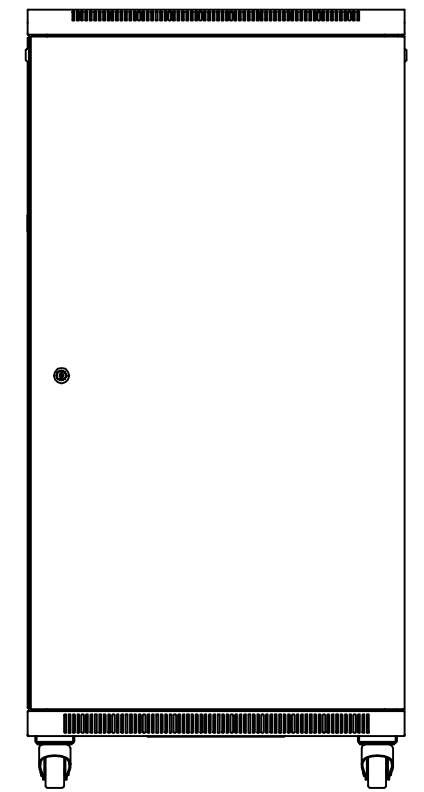

BACK VIEW

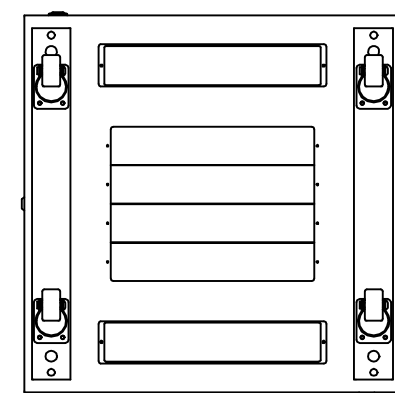

BOTTOM VIEW

TOLERANCE ALL DIMENSIONS: ±0.08" [2.0]

		ITEM	REQ'D.	PART NO.	DESCRIPTION	
QTY.	USED ON	TOLERANCES:			NAME: 24U BUDRACK PROFESSIONAL SERIES DWG. NO. BRP-12202	
		±.005 BETWEEN HOLE CENTERS				MAT: AS NOTED
		±.015 FROM SHEARED EDGE				FINISH: AS NOTED
		±.032 FROM A BENT SURFACE				DR. DAB 6-20-08
		UNLESS OTHERWISE SPECIFIED			 BUD INDUSTRIES, INC. WILLOUGHBY, OHIO	
		CH.				
		APP.				